



La référence de la porte relevante

Catalogue PDR

Porte FIT Forty Clever



www.fit-doors.fr

FIT

6, Rue du Parc des Vergers

91250 TIGERY

Tél: 01 69 90 69 69

Mail: info@fit-doors.fr

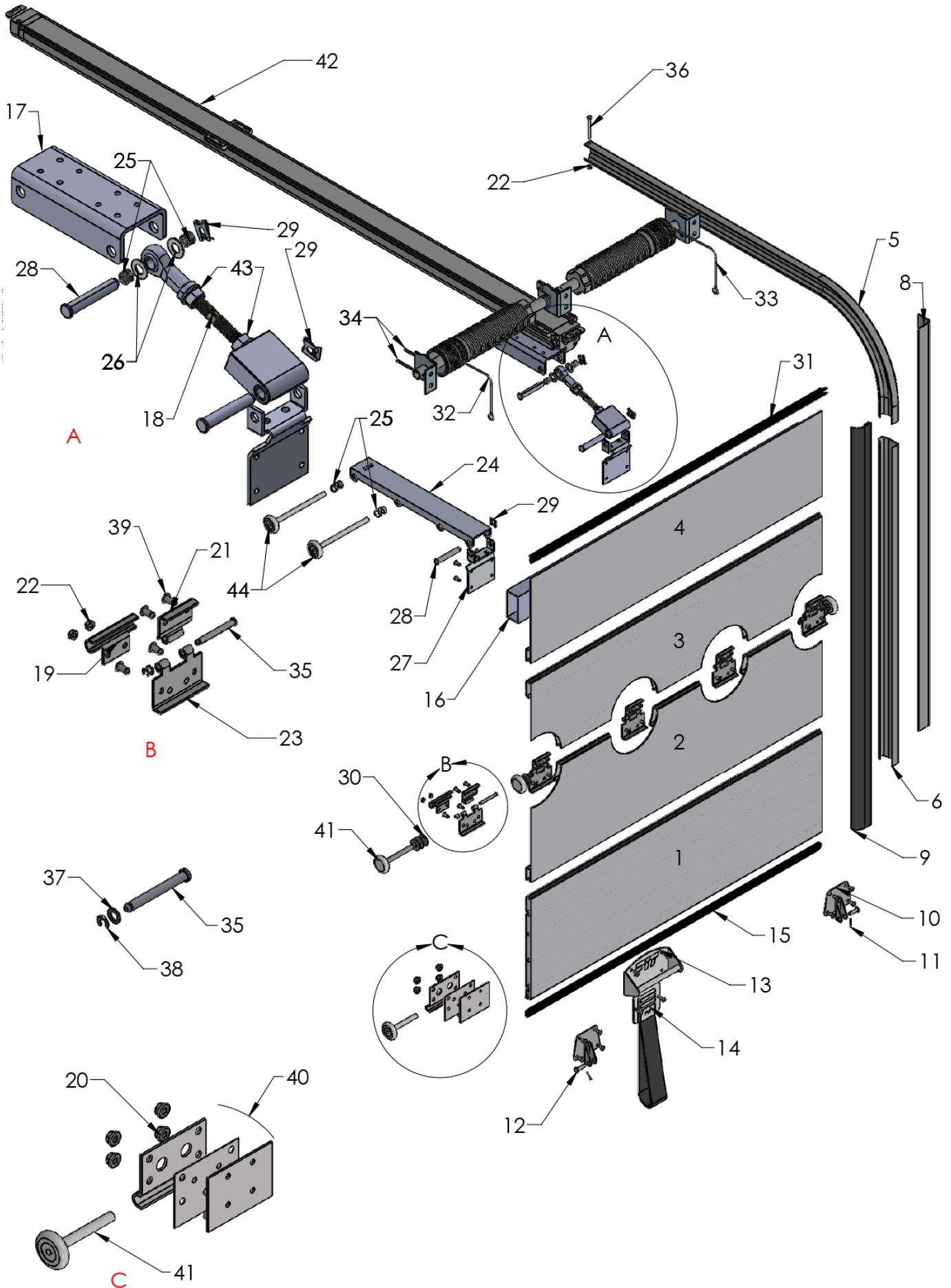

ROULETTES

Roulette FIT+

41



Roulement
RS 6200

0.128 kg MPEP0021-R

Roulette FIT Max

41



Roulement
RS 6200

0.133 kg MPEP0801

Roulette nylon longue

41



Tige longue

0.195 kg MPEP0896

Roulette nylon longue tige Inox

41



Tige longue

0.203 kg MPEP0897

KIT Roulette axe long haute (option)

44-25-26

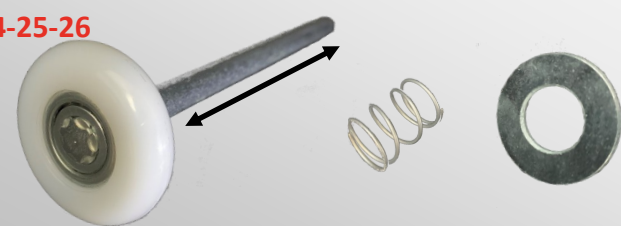

0.203 kg FPPEP0200

KIT Roulette haute FIT Max Pneumatique (standard)

44-25-26



0.142 kg FPPEP0195

CALAGE

Sachet de 16 rondelles de calage

30



0.001 kg MPVQ0089-16

Ressort de calage

25



0.003 kg PPEP0198

Rondelle pour ressort de calage

26



0.008 kg MPVQ0251

CHARNIERES

Axe de charnière complet

35-37-38

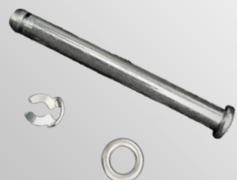

0.015 kg

FMPVQ0095

Charnière centrale



kg

FPYEP0009

Charnière support roulette complète

B

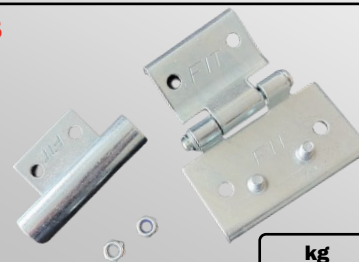

kg

FPYEP0010

Bras de guidage VST FIT Clever

24



kg

PPOD0521

Axe d'articulation pour support haut Inox

28



KG

MPEP0796

Clip de blocage Boite de 100

29

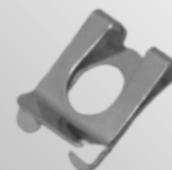

MPVQ0818

Guide de roulette

19



kg

PYEP0008

Support haut VST FIT Clever

27



kg

PPOD0520

Support roulette bas renforcé

C

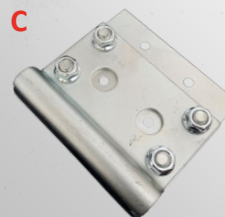

0.431 kg

FPIEP0073

Rivet Hemlock Acier



kg

PYVQ0010

JOINTS

Joint haut Lg 2700 mm

31

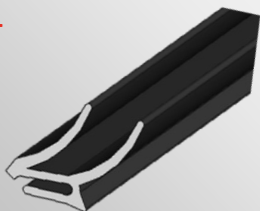

kg

PPJ000142700

Joint bas Le mètre linéaire

15



0.099 kg

PBJ00292

Joint haut pour montage sur cadre arrière

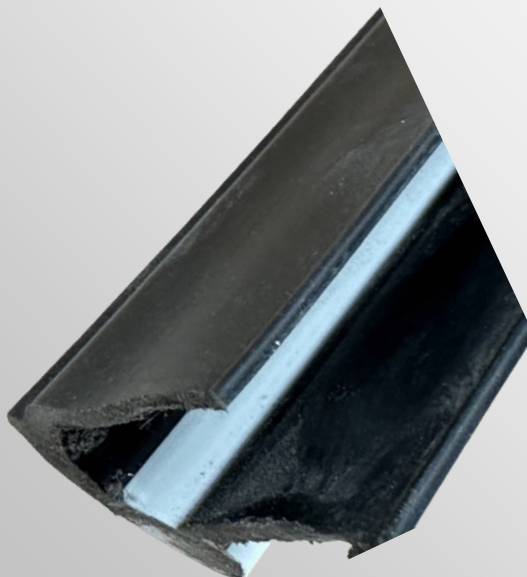

kg

PIJ00024

Joint bas Lg 2450 mm

15



0.243 kg

PBJ00293

Joint latéral longueur 2880 mm

9

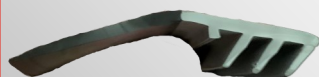

0.224 kg

PBJ001822880

Renfort section haute VAT

16

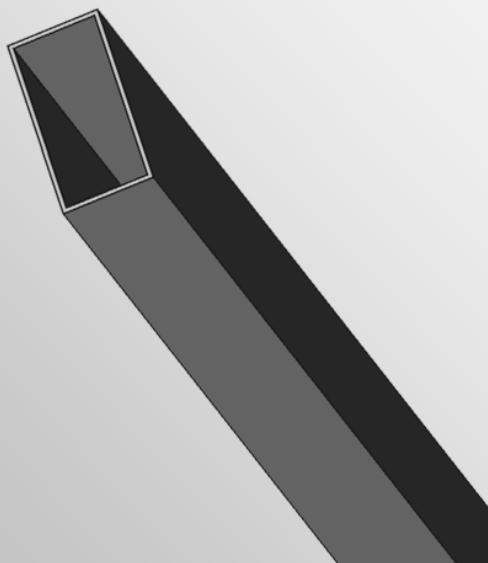

kg

PBTA0309

SECTIONS

Porte FIT Forty

0.00 KG

Section haute seule

4

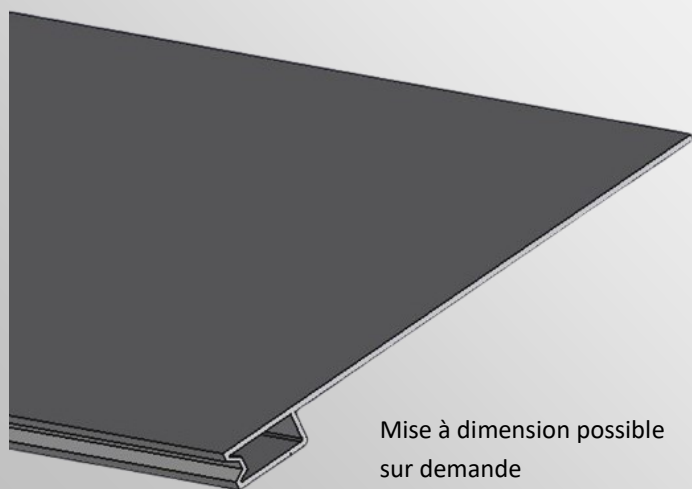

Mise à dimension possible sur demande

0.00 KG

Section haute complète Clever

4-16-27-31

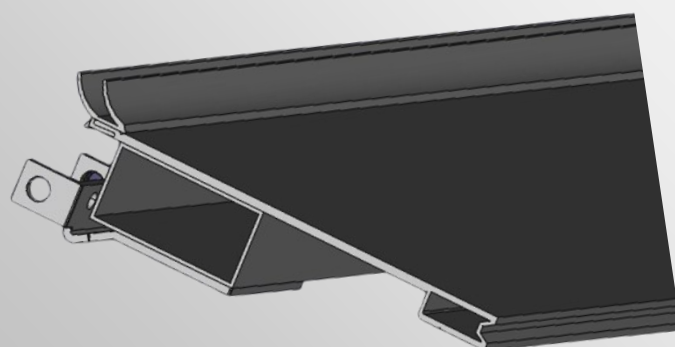

Mise à dimension possible sur demande

FPYTA0009 CLEVER PDR

0.00 KG

Section intermédiaire Hauteur 245 mm

3

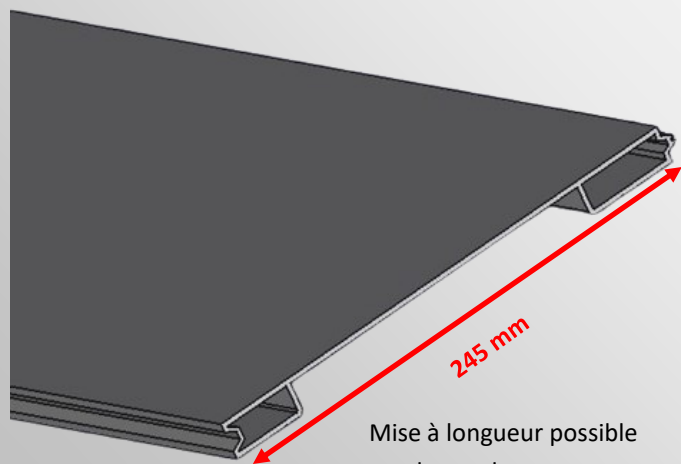

Mise à longueur possible sur demande

PYTA0002

0.00 KG

Section intermédiaire Hauteur 300 mm

2

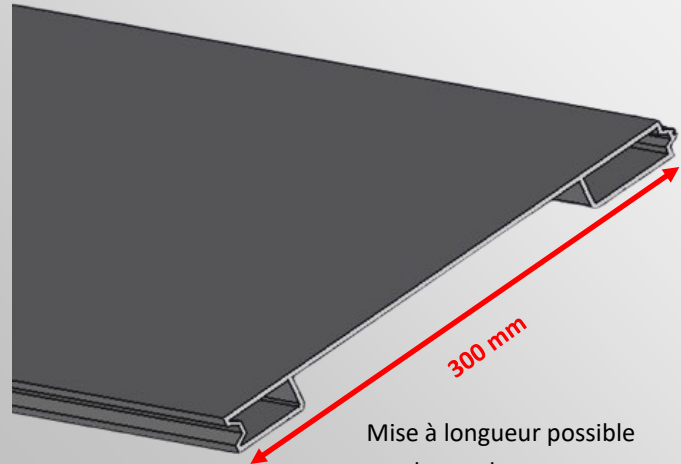

Mise à longueur possible sur demande

PYTA0003

SECTIONS

Porte FIT Forty

0.00 KG

Section basse seule

1

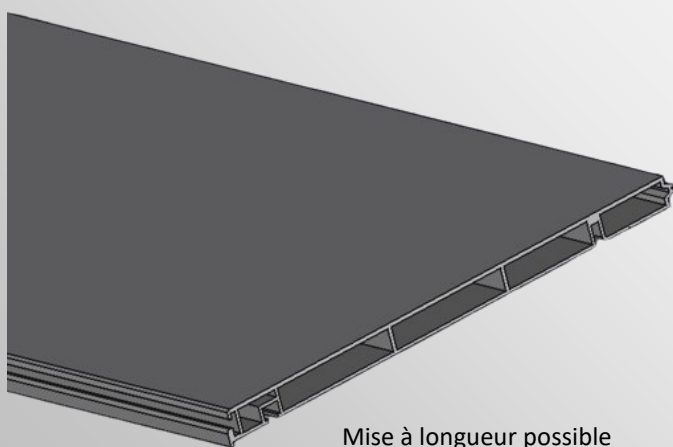

Mise à longueur possible
sur demande

PYTA0001

0.00 KG

Section basse profilé + joint

1-15

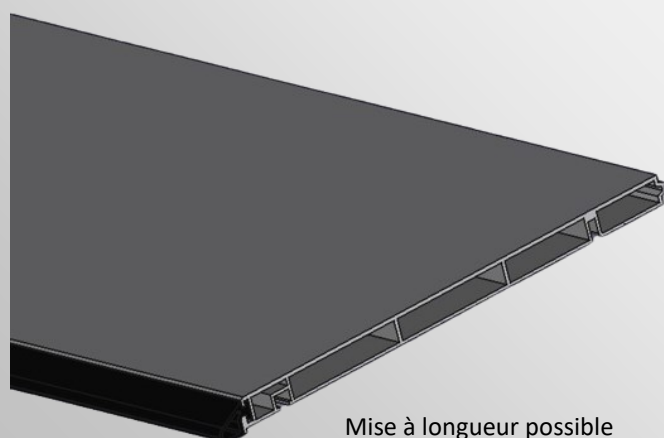

Mise à longueur possible
sur demande

FPYTA0011

0.00 KG

Section basse complète

1-10-13-14-15-C

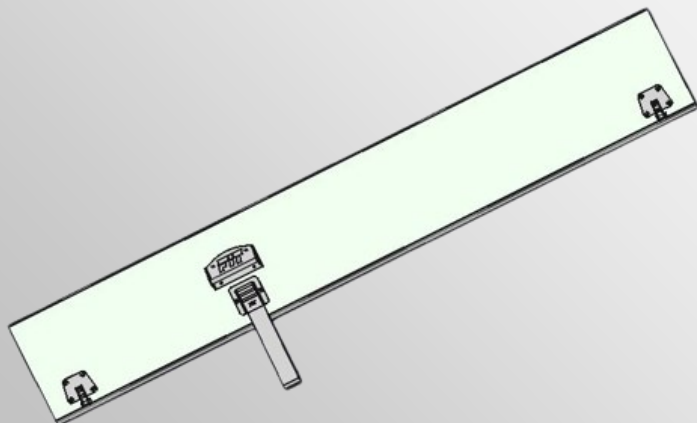

Mise à longueur possible

FPYTA0011

RAILS

Ens. Cornière / Rail droit
long : 2971 / 2616 mm

6
8

la paire



KG

FMPRC0527

Rail droit vertical 2",
(sans cornière) L :3291 mm

6

Unitaire

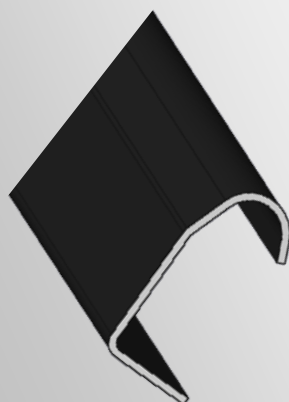

KG

MPRC0003

Rail courbe 2", rayon 254 mm

5

la paire

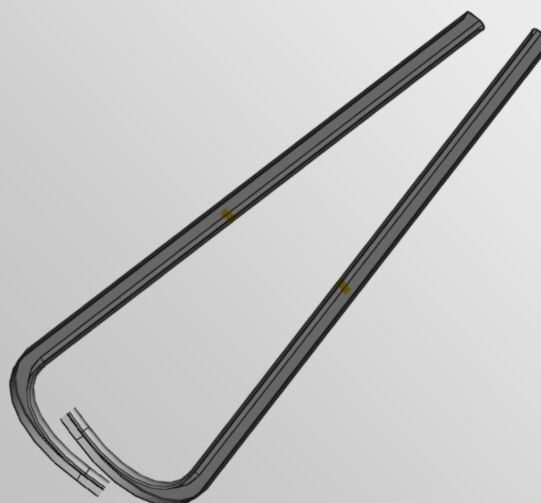

KG

FMPRC0005

Vis + boulon de butée

22-36

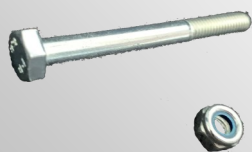

0.080 KG

FMPVQ0054

PASSAGER



Ensemble ressort 3.2 x 240

GRIS 429 mm

FMPEQ0713Z

KG

Ensemble ressort 3.4 X 315

ORANGE 503 mm

FMPEQ0757Z

KG

Ensemble ressort 3.9 x 445

BLEU 637 mm

FMPEQ0771Z

KG

Ensemble ressort 4.3 x 635

JAUNE 837 mm

FMPEQ0757Z

KG

Ensemble ressort 4.5 x 737

MARRON 880 mm

FMPEQ0779Z

KG

Ensemble ressort 4.9 x 813

VERT 1024 mm

FMPEQ1024

KG

RESSORTS

Tambour enrouleur mixte



0.287 KG

FMPEQ0394

CHAUFFEUR



Ensemble ressort 3.2 x 240

GRIS 429 mm

FMPEQ0714Z

KG

Ensemble ressort 3.4 X 315

ORANGE 503 mm

FMPEQ0756Z

KG

Ensemble ressort 3.9 x 445

BLEU 637 mm

FMPEQ0770Z

KG

Ensemble ressort 4.3 x 635

JAUNE 837 mm

FMPEQ0756Z

KG

Ensemble ressort 4.5 x 737

MARRON 880 mm

FMPEQ0778Z

KG

Ensemble ressort 4.9 x 813

VERT 1024 mm

FMPEQ1025

KG

Arbre longueur 2210 mm ZINGUE

FPBEQ0173Z

KG

Arbre longueur 2311 mm ZINGUE

FPBEQ0172Z

KG



Goupille fendue

31

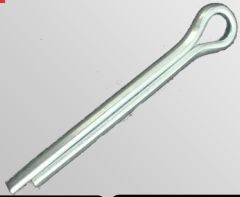

0.007 KG

PBVQ0206

EQUILIBREURS

Jeu complet de support



0.701 KG

PBEQ0137

36



Complet 3.2 x 240	long : 990 mm	ZINGUE	FMPEQ0710Z	KG
Complet 3.4 x 315	long :1 140 mm	ZINGUE	FMPEQ0768Z	KG
Complet 3.4 x 315	long :1 340 mm	ZINGUE	FMPEQ0769Z	KG
Complet 3.9 x 445	long :1 470 mm	ZINGUE	FMPEQ0772Z	KG
Complet 3.9 x 445	long :1 530 mm	ZINGUE	FMPEQ0773Z	KG
Complet 3.9 x 445	long :1 590 mm	ZINGUE	FMPEQ0774Z	KG
Complet 3.9 x 445	long :1 650 mm	ZINGUE	FMPEQ0775Z	KG
Complet 3.9 x 445	long :1 710 mm	ZINGUE	FMPEQ0776Z	KG
Complet 3.9 x 445	long :1 770 mm	ZINGUE	FMPEQ0777Z	KG
Complet 4.3 x 635	long :1 829 mm	ZINGUE	FMPEQ0758Z	KG
Complet 4.3 x 635	long :1 880 mm	ZINGUE	FMPEQ0759Z	KG
Complet 4.3 x 635	long :1 930 mm	ZINGUE	FMPEQ0760Z	KG
Complet 4.3 x 635	long :1 981 mm	ZINGUE	FMPEQ0761Z	KG
Complet 4.5 x 737	long :2 032 mm	ZINGUE	FMPEQ0780Z	KG
Complet 4.5 x 737	long :2 083 mm	ZINGUE	FMPEQ0781Z	KG
Complet 4.5 x 737	long :2 134 mm	ZINGUE	FMPEQ0782Z	KG
Complet 4.5 x 737	long :2 210 mm	ZINGUE	FMPEQ0783Z	KG
Complet 4.9 x 815	long :2 210 mm	ZINGUE	FMPEQ1021	KG
Complet 4.9 x 815	long :2 311 mm	ZINGUE	FPPEQ0062	KG

VERINS ET ACCESSOIRES

Coffret électropneumatique 12V complet

12 Volt

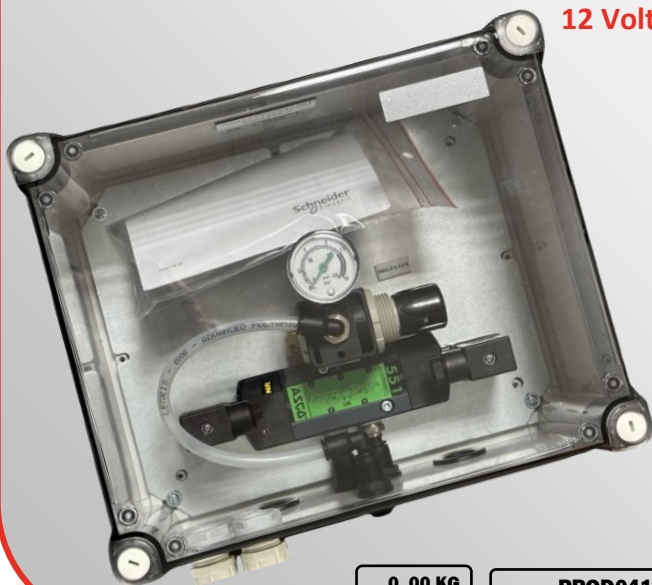

0.00 KG

PPOD0415

Coffret électropneumatique 24V complet

24 Volt

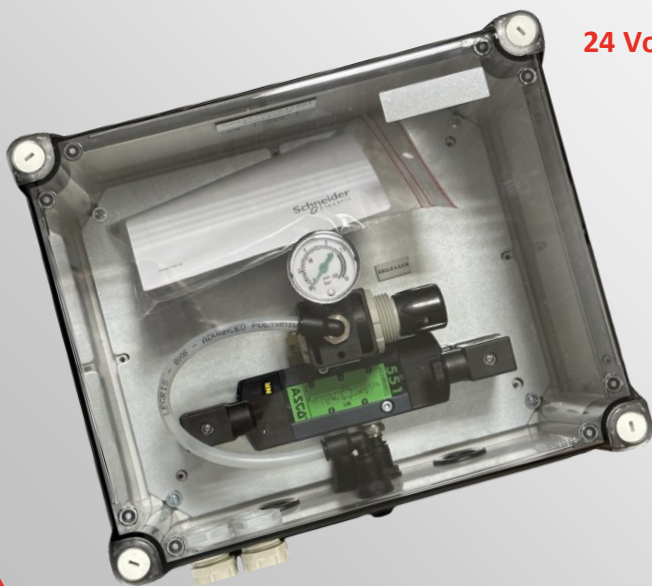

0.00 KG

PPOD0410

Coffret 100% pneumatique 2 commandes

100% Pneumatique

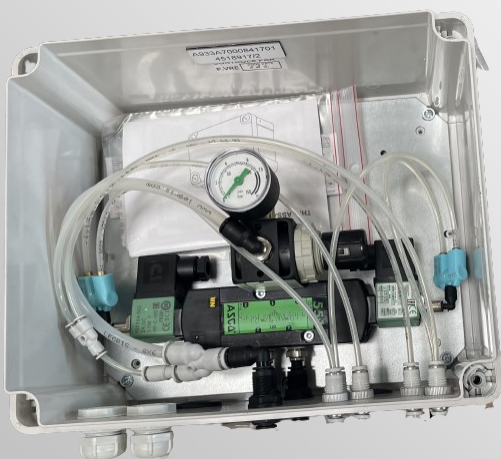

0.00 KG

PPOD0310

Distributeur G551 Bi-Cde FIT

Bi commande

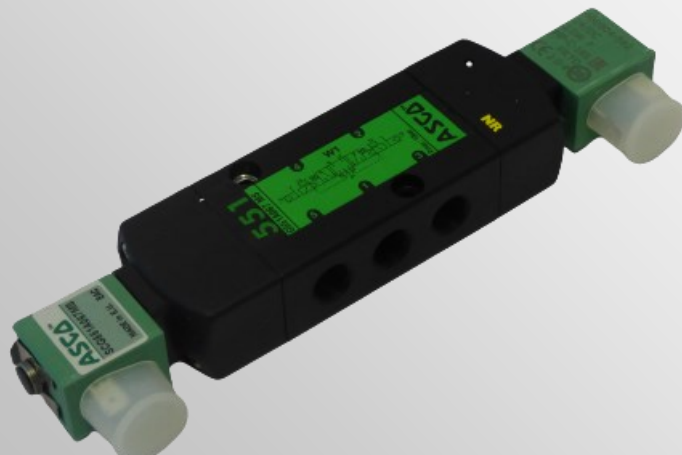

0.00 KG

PPOD0443

VERINS ET ACCESSOIRES

Bobine 12V distributeur FIT G551

12 Volt



KG PPEP0152

Bobine 24V distributeur FIT G551

24 Volt



KG PPEP0153

Régulateur de pression G1/4 AS



KG PPOD0444

Manomètre AS



KG PPEP0181

Silencieux limiteur de débit



KG PPOD0437

Equerre de piquage coudée
Ø 8 pour régléur



KG SHAU0225

Raccord de piquage
coudé Ø 8 VAT



KG SHAU0114

Cellule OU



KG PPOD0445

Tube rylsan Ø 4mm
(Lg 25 mètres)



KG SHAU0118

Tube rylsan Ø 8mm
(Lg 25 mètres)



KG SHAU0239

Y pour tube Ø 4



KG SHAU0119

Y pour tube Ø 8



KG REF????

Adaptateur métal pour Microvalve

100% Pneu



KG SHAU0121

Bouton Rouge pour Microvalve

100%



KG SHAU0122

Bouton Vert pour Microvalve

100%



KG SHAU0123

Microvalve NF 100% pneumatique

100% Pneu



KG PPEP0120

VERINS ET ACCESSOIRES

Boitier de commande 2 boutons



Electro Pneu

KG PPEP0115

Commande extra plate 2 boutons



Electro Pneu

KG PPEP0116

Temporisation électropneumatique



KG MPEP0957

Vérin sans tige 3200 mm SEC

42



KG SHAU0116

Embase VST FIT Clever

17



KG PPOD0520

Axe pour Embase Clever

??



KG PPOD0523

Rotule VST FIT Clever



KG PPOD0529

Pièce de liaison VST FIT



KG PPOD0522

Barre de liaison VST FIT Clever SEC

18



KG PPOD0526

Ressort de calage

25



0.003 kg PPEP0198

Rondelle pour embase Clever

26



KG MPVQ1101

Equerre de fixation VST

La paire



KG SHAU0134

Fixation par patte d'équerre



KG SHAU0135

Bloqueur de section VST

La paire



KG SHAU0138

VERINS ET ACCESSOIRES

Racleurs VST

La paire



KG SHAU0133

Pochette de joints VST SEC



KG SHAU0135

Bande intérieure VST 3200 SEC



KG ????

Bande extérieure VST 3200 SEC

KG SHAU0132



FIT La référence de la porte relevante



www.fit-doors.fr

FIT

6, Rue du Parc des Vergers

91250 TIGERY

Tél: 01 69 90 69 69 Fax: 01 69 90 02 52

Mail: info@fit-doors.fr